

NPN Silicon Power Transistors High Voltage Planar

MJW18020

The MJW18020 planar High Voltage Power Transistor is specifically Designed for motor control applications, high power supplies and UPS's for which the high reproducibility of DC and Switching parameters minimizes the dead time in bridge configurations.

Features

- High and Excellent Gain Linearity
- Fast and Very Tight Switching Times Parameters t_{si} and t_{fi}
- Very Stable Leakage Current due to the Planar Structure
- High Reliability
- Pb-Free Package is Available*

MAXIMUM RATINGS

Rating	Symbol	Value	Unit
Collector-Emitter Sustaining Voltage	V_{CEO}	450	Vdc
Collector-Emitter Breakdown Voltage	V_{CES}	1000	Vdc
Collector-Base Voltage	V_{CBO}	1000	Vdc
Emitter-Base Voltage	V_{EBO}	9.0	Vdc
Collector Current – Continuous – Peak (Note 1)	I_C	30 45	Adc
Base Current – Continuous – Peak (Note 1)	I_B	6.0 10	Adc
Total Power Dissipation @ $T_C = 25^\circ\text{C}$ Derate Above 25°C	P_D	250 2.0	W W/ $^\circ\text{C}$
Operating and Storage Junction Temperature Range	T_J, T_{stg}	-65 to +150	$^\circ\text{C}$

THERMAL CHARACTERISTICS

Characteristic	Symbol	Max	Unit
Thermal Resistance, Junction-to-Case	$R_{\theta JC}$	0.5	$^\circ\text{C}/\text{W}$
Thermal Resistance, Junction-to-Ambient	$R_{\theta JA}$	50	$^\circ\text{C}/\text{W}$
Maximum Lead Temperature for Soldering Purposes: 1/8" from Case for 5 Seconds	T_L	275	$^\circ\text{C}$

Stresses exceeding those listed in the Maximum Ratings table may damage the device. If any of these limits are exceeded, device functionality should not be assumed, damage may occur and reliability may be affected.

1. Pulse Test: Pulse Width = 5 μs , Duty Cycle $\leq 10\%$.

*For additional information on our Pb-Free strategy and soldering details, please download the **onsemi** Soldering and Mounting Techniques Reference Manual, SOLDERRM/D.

30 AMPERES
 1000 VOLTS BV_{CES}
 450 VOLTS BV_{CEO} , 250 WATTS

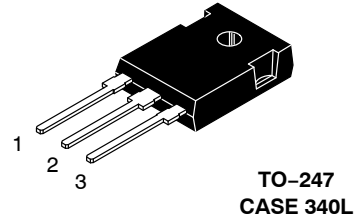

MARKING DIAGRAM

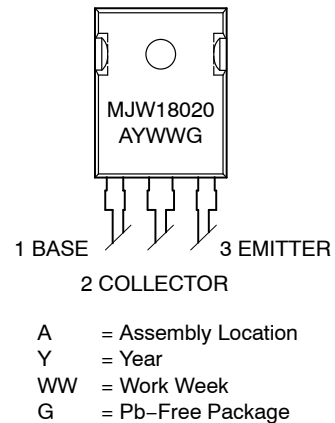

ORDERING INFORMATION

Device	Package	Shipping
MJW18020	TO-247	30 Units/Rail
MJW18020G	TO-247 (Pb-Free)	30 Units/Rail

MJW18020

ELECTRICAL CHARACTERISTICS (T_C = 25°C unless otherwise noted)

Characteristic	Symbol	Min	Typ	Max	Unit
OFF CHARACTERISTICS					
Collector-Emitter Sustaining Voltage (I _C = 100 mA _{dc} , I _B = 0)	V _{CEO(sus)}	450	–	–	V _{dc}
Collector Cutoff Current (V _{CE} = Rated V _{CEO} , I _B = 0)	I _{CEO}	–	–	100	μA _{dc}
Collector Cutoff Current (V _{CE} = Rated V _{CES} , V _{EB} = 0) (T _C = 125°C)	I _{CES}	–	–	100 500	μA _{dc}
Emitter Cutoff Current (V _{CE} = 9 V _{dc} , I _C = 0)	I _{EBO}	–	–	100	μA _{dc}

ON CHARACTERISTICS

DC Current Gain (I _C = 3 A _{dc} , V _{CE} = 5 V _{dc}) (I _C = 10 A _{dc} , V _{CE} = 2 V _{dc}) (I _C = 20 A _{dc} , V _{CE} = 2 V _{dc}) (I _C = 10 mA _{dc} , V _{CE} = 5 V _{dc})	(T _C = 125°C)	h _{FE}	14 – 8 5 5.5 4 14	30 – 16 14 9 7 25	34 – – – – – –	
	(T _C = 125°C)					
	(T _C = 125°C)					
	(T _C = 125°C)					
	(T _C = 125°C)					
Base-Emitter Saturation Voltage (I _C = 10 A _{dc} , I _B = 2 A _{dc}) (I _C = 20 A _{dc} , I _B = 4 A _{dc})	V _{BE(sat)}	–	0.97 1.15	1.25 1.5	V _{dc}	
Collector-Emitter Saturation Voltage (I _C = 10 A _{dc} , I _B = 2 A _{dc}) (I _C = 20 A _{dc} , I _B = 4 A _{dc})	V _{CE(sat)}	– – – –	0.2 0.3 0.5 0.9	0.6 – 1.5 2.0	V _{dc}	(T _C = 125°C) (T _C = 125°C)

DYNAMIC CHARACTERISTICS

Current Gain Bandwidth Product (I _C = 1 A _{dc} , V _{CE} = 10 V _{dc} , f _{test} = 1 MHz)	f _T	–	13	–	MHz
Output Capacitance (V _{CB} = 10 V _{dc} , I _E = 0, f _{test} = 1 MHz)	C _{ob}	–	300	500	pF
Input Capacitance (V _{EB} = 8.0)	C _{ib}	–	7000	9000	pF

SWITCHING CHARACTERISTICS: Resistive Load (D.C. = 10%, Pulse Width = 70 μs)

Turn-On Time	(I _C = 10 A _{dc} , I _{B1} = I _{B2} = 2 A _{dc} , V _{CC} = 125 V)	t _{On}	–	540	750	ns
Storage Time		t _s	–	4.75	6	μs
Fall Time		t _f	–	380	500	ns
Turn-Off Time		t _{Off}	–	5.2	6.5	μs
Turn-On Time	(I _C = 20 A _{dc} , I _{B1} = I _{B2} = 4 A _{dc} , V _{CC} = 125 V)	t _{On}	–	965	1200	ns
Storage Time		t _s	–	2.9	3.5	μs
Fall Time		t _f	–	350	500	ns
Turn-Off Time		t _{Off}	–	3.25	4	μs

SWITCHING CHARACTERISTICS: Inductive Load (V_{clamp} = 300 V, V_{CC} = 15 V, L = 200 μH)

Fall Time	(I _C = 10 A _{dc} , I _{B1} = I _{B2} = 2 A _{dc})	t _{fi}	–	142	250	ns
Storage Time		t _{si}	–	4.75	6	μs
Crossover Time		t _c	–	320	500	ns
Fall Time	(I _C = 20 A _{dc} , I _{B1} = I _{B2} = 4 A _{dc})	t _{fi}	–	350	500	ns
Storage Time		t _{si}	–	3.0	3.5	μs
Crossover Time		t _c	–	500	750	ns

TYPICAL CHARACTERISTICS

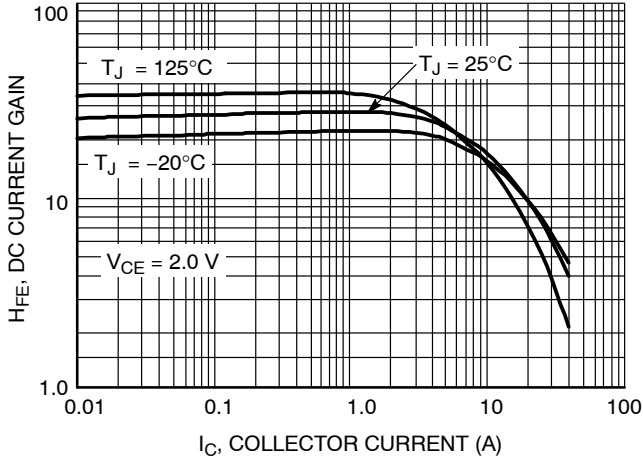

Figure 1. DC Current Gain, $V_{CE} = 2.0\text{ V}$

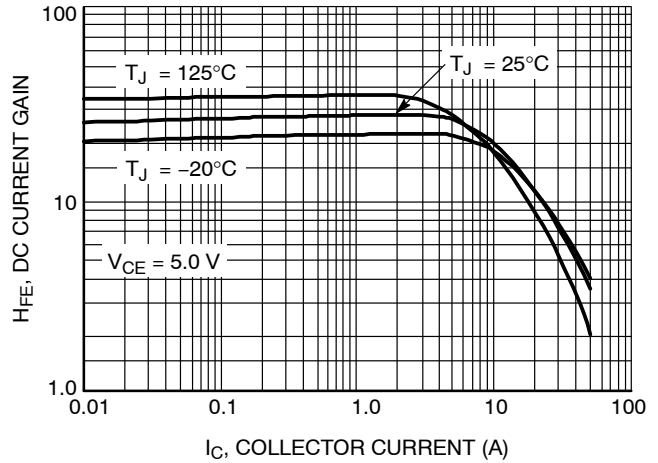

Figure 2. DC Current Gain, $V_{CE} = 5.0\text{ V}$

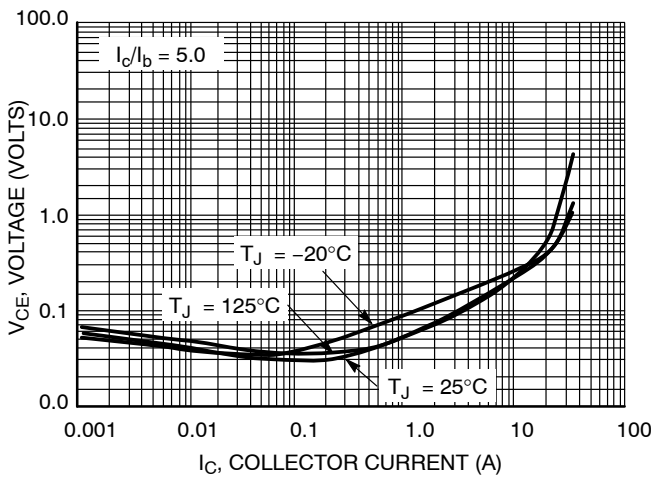

Figure 3. Typical Collector-Emitter Saturation Voltage, $I_C/I_B = 5.0$

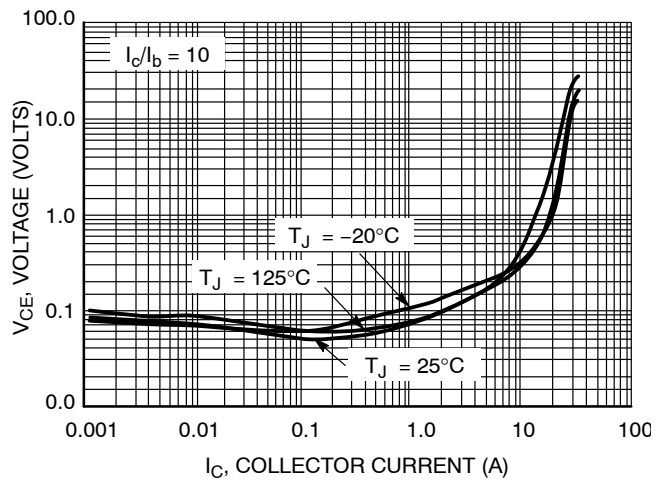

Figure 4. Typical Collector-Emitter Saturation Voltage, $I_C/I_B = 10$

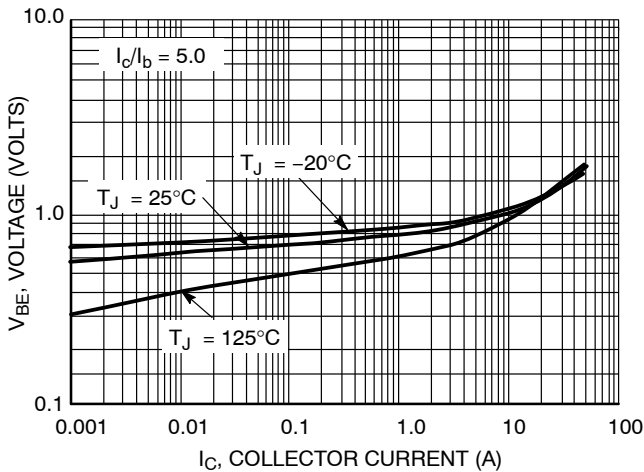

Figure 5. Typical Base-Emitter Saturation Voltage, $I_C/I_B = 5.0$

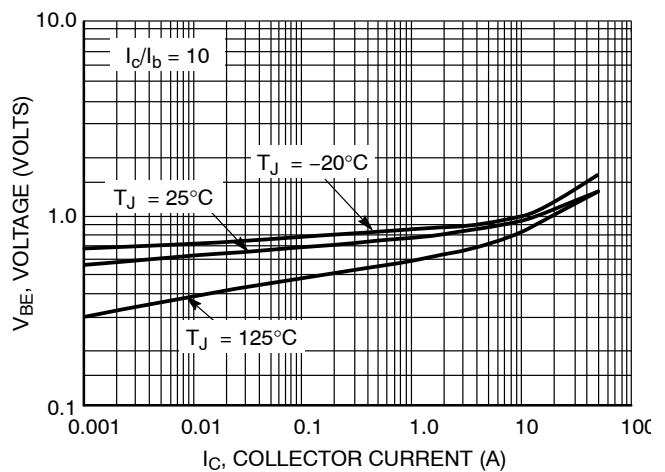

Figure 6. Typical Base-Emitter Saturation Voltage, $I_C/I_B = 10$

TYPICAL CHARACTERISTICS

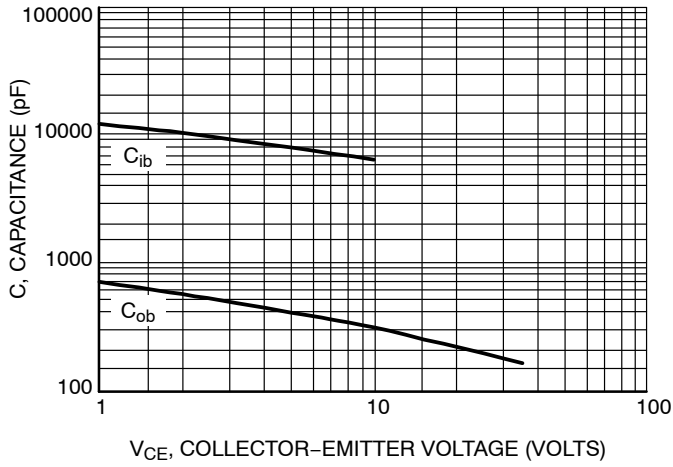

Figure 7. Typical Capacitance

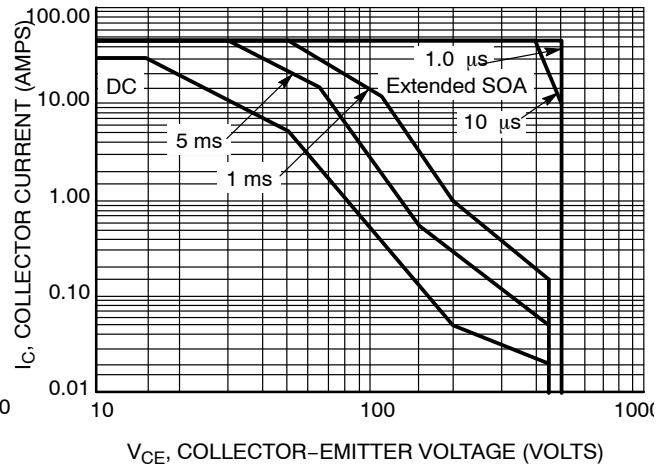

Figure 8. Forward Bias Safe Operating Area

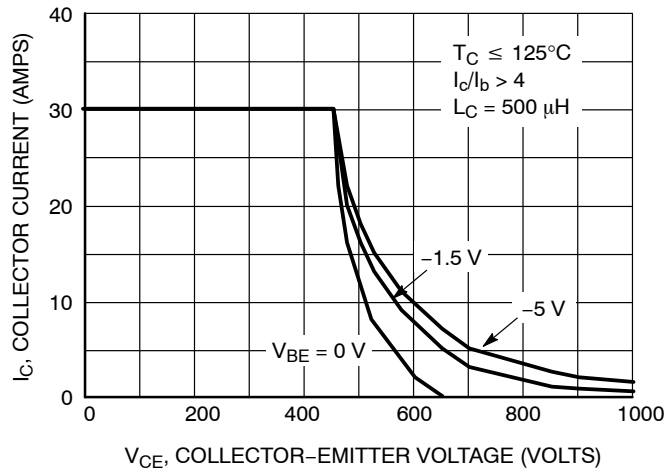
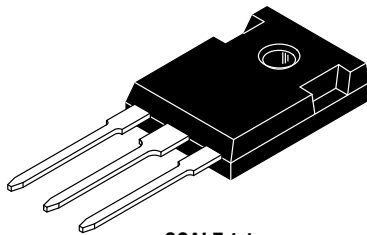

Figure 9. Reverse Bias Safe Operating Area



TO-247
CASE 340L
ISSUE G

DATE 06 OCT 2021

SCALE 1:1

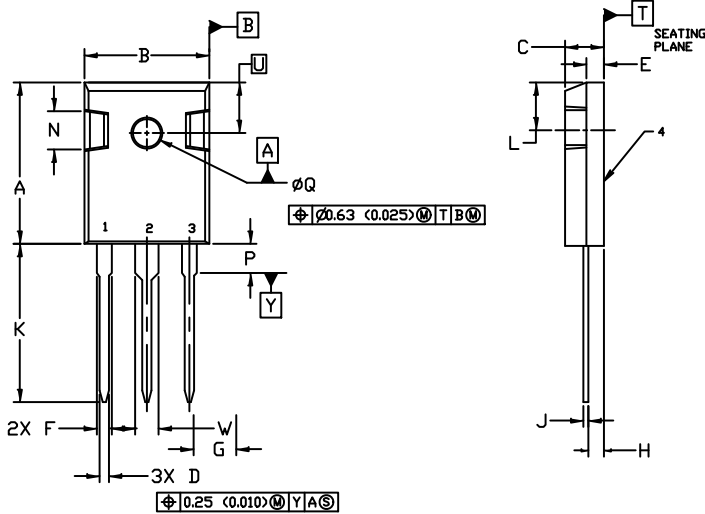

NOTES:

1. DIMENSIONING AND TOLERANCING PER ASME Y14.5M, 1982.
2. CONTROLLING DIMENSION: MILLIMETER

DIM	MILLIMETERS		INCHES	
	MIN.	MAX.	MIN.	MAX.
A	20.32	21.08	0.800	0.830
B	15.75	16.26	0.620	0.640
C	4.70	5.30	0.185	0.209
D	1.00	1.40	0.040	0.055
E	1.90	2.60	0.075	0.102
F	1.65	2.13	0.065	0.084
G	5.45 BSC		0.215 BSC	
H	1.50	2.49	0.059	0.098
J	0.40	0.80	0.016	0.031
K	19.81	20.83	0.780	0.820
L	5.40	6.20	0.212	0.244
N	4.32	5.49	0.170	0.216
P	----	4.50	----	0.177
Q	3.55	3.65	0.140	0.144
U	6.15 BSC		0.242 BSC	
W	2.87	3.12	0.113	0.123

GENERIC
MARKING DIAGRAM*

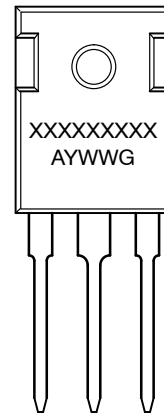

- | | | | |
|--|--|--|--|
| <p>STYLE 1:
PIN 1. GATE
2. DRAIN
3. SOURCE
4. DRAIN</p> | <p>STYLE 2:
PIN 1. ANODE
2. CATHODE (S)
3. ANODE 2
4. CATHODES (S)</p> | <p>STYLE 3:
PIN 1. BASE
2. COLLECTOR
3. EMITTER
4. COLLECTOR</p> | <p>STYLE 4:
PIN 1. GATE
2. COLLECTOR
3. EMITTER
4. COLLECTOR</p> |
| <p>STYLE 5:
PIN 1. CATHODE
2. ANODE
3. GATE
4. ANODE</p> | <p>STYLE 6:
PIN 1. MAIN TERMINAL 1
2. MAIN TERMINAL 2
3. GATE
4. MAIN TERMINAL 2</p> | | |

- XXXXX = Specific Device Code
A = Assembly Location
Y = Year
WW = Work Week
G = Pb-Free Package

*This information is generic. Please refer to device data sheet for actual part marking. Pb-Free indicator, "G" or microdot "•", may or may not be present. Some products may not follow the Generic Marking.

DOCUMENT NUMBER:	98ASB15080C	Electronic versions are uncontrolled except when accessed directly from the Document Repository. Printed versions are uncontrolled except when stamped "CONTROLLED COPY" in red.
DESCRIPTION:	TO-247	PAGE 1 OF 1

onsemi and onsemi are trademarks of Semiconductor Components Industries, LLC dba onsemi or its subsidiaries in the United States and/or other countries. onsemi reserves the right to make changes without further notice to any products herein. onsemi makes no warranty, representation or guarantee regarding the suitability of its products for any particular purpose, nor does onsemi assume any liability arising out of the application or use of any product or circuit, and specifically disclaims any and all liability, including without limitation special, consequential or incidental damages. onsemi does not convey any license under its patent rights nor the rights of others.

onsemi, **Onsemi**, and other names, marks, and brands are registered and/or common law trademarks of Semiconductor Components Industries, LLC dba "**onsemi**" or its affiliates and/or subsidiaries in the United States and/or other countries. **onsemi** owns the rights to a number of patents, trademarks, copyrights, trade secrets, and other intellectual property. A listing of **onsemi**'s product/patent coverage may be accessed at www.onsemi.com/site/pdf/Patent-Marking.pdf. **onsemi** reserves the right to make changes at any time to any products or information herein, without notice. The information herein is provided "as-is" and **onsemi** makes no warranty, representation or guarantee regarding the accuracy of the information, product features, availability, functionality, or suitability of its products for any particular purpose, nor does **onsemi** assume any liability arising out of the application or use of any product or circuit, and specifically disclaims any and all liability, including without limitation special, consequential or incidental damages. Buyer is responsible for its products and applications using **onsemi** products, including compliance with all laws, regulations and safety requirements or standards, regardless of any support or applications information provided by **onsemi**. "Typical" parameters which may be provided in **onsemi** data sheets and/or specifications can and do vary in different applications and actual performance may vary over time. All operating parameters, including "Typicals" must be validated for each customer application by customer's technical experts. **onsemi** does not convey any license under any of its intellectual property rights nor the rights of others. **onsemi** products are not designed, intended, or authorized for use as a critical component in life support systems or any FDA Class 3 medical devices or medical devices with a same or similar classification in a foreign jurisdiction or any devices intended for implantation in the human body. Should Buyer purchase or use **onsemi** products for any such unintended or unauthorized application, Buyer shall indemnify and hold **onsemi** and its officers, employees, subsidiaries, affiliates, and distributors harmless against all claims, costs, damages, and expenses, and reasonable attorney fees arising out of, directly or indirectly, any claim of personal injury or death associated with such unintended or unauthorized use, even if such claim alleges that **onsemi** was negligent regarding the design or manufacture of the part. **onsemi** is an Equal Opportunity/Affirmative Action Employer. This literature is subject to all applicable copyright laws and is not for resale in any manner.

ADDITIONAL INFORMATION

TECHNICAL PUBLICATIONS:

Technical Library: www.onsemi.com/design/resources/technical-documentation
onsemi Website: www.onsemi.com

ONLINE SUPPORT: www.onsemi.com/support

For additional information, please contact your local Sales Representative at www.onsemi.com/support/sales